



Comune di Toano

Provincia di Reggio Emilia

corso Trieste, 65
42010 Toano (RE)
tel. 0522 805110 . fax 0522 805542
protocollo@comune.toano.re.it

progettazione

Studio Togninelli ingegneria

restauro e consolidamento . ingegneria sismica . calcoli strutturali . progettazione . sicurezza

ing. Gianluca Togninelli
ing. Marco Iattici Romei

via Aldo Moro, 2/a
42035 Castelnovo ne' Monti (RE)
tel. 0522 1170328
info@studiotogninelli.it

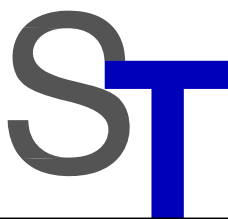

progetto

**realizzazione di nuova struttura sociale
di comunità da adibire a centro socio
riabilitativo semiresidenziale per disabili
"Erica" e centro di terapia
occupazionale "Labor"**

PNRR M5C3 LINEA DI INTERVENTO 1.1.1

CUP: F75E22000300006

cod. protocollo pratica
2022/018

elaborato

committente
Comune di Toano

**tavola di progetto:
Raccolta schemi elettrici**

RUP e responsabile del servizio
geom. Erica Bondi

tavola

E3.7







































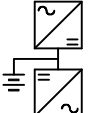

progettista, CSP, DL, DLS e CSE
ing. Gianluca Togninelli

scale

-

rev	data
00	nov/2023

ŠÒÒÒPÖE
ÙQ ÓUŠQ

									
QV0UUVVU0ÁEWT0E0U	ÚQW0E0U0U0	QV0UUVVU0ÁE0Q T0E0U0E0W0E0U0E0U0	ÚUUV0ZW0E0Á0ÚT0E0E	ÚUUV0ZW0E0Á0E0P0N0E0E	ÚUUV0ZW0E0Á0E0W0U0P0Z0E0S0	ÚE0X0E0U0V0U0	ÓS0T0E0VU0E0W0E0S0	VU0U0E0	ÓUT0E0U0Á0E0W0E0S0
									
ÓUT0E0U0Á0E0U0V0U0Z0E0U	Ú0E0E0W0E0W0U0	T0E0U0X0E0U0V0E0Q0E0 ÓS0Ó0U0U0V0E0	QV0Ú0S0U0	QE0U0E0Ó0P0E0W0U0E0 Ú0U0X0E0S0E0U0V0E0S0	ÓS0Ó0U0Á0E0P0E0X0E0S0Ó0E0U0 ÓU0P0Á0E0U0E0Ó0P0E0W0E0Á0U0Z0E0P0 Ó0W0U0U0	ÓS0Ó0U0Á0E0P0E0X0E0S0Ó0E0U0 QE0U0E0Ó0P0E0W0E0Á0U0Z0E0P0E0Q0 U0U0U0	ÓU0P0V0E0U0Á0E0W0E0P0E0WT0U0U0Q0 ÓU0P0V0E0U0Á0E0W0E0S0E0S0 VU0E0V0Ó0W0E0P0E0W0E0S0 Ú0E0V0E0S0S0E0U0E0Ó0P0E0W0U0E0 E0W0Ó0Á0W0S0U0P0E0V0U0	ÓU0P0E0E0E0E0E0E0P0U0W0P0	ÓU0P0E0E0E0E0E0E0W0U0U0P0
									
ÓUT0E0W0E0U0Á0E0U0V0U0T0E0V0Q0 Q0S0T0Ó0U0E0E0E0U0U0T0Ó0U0E0U0	QE0U0Ó0U0T0Ó0U0	XUŠ0T0Ó0U0	E0Ó0W0E0Z0E0Ó0U0	ÚU0W0E0VU0Á0E0V0Ó0E0U0 Q0U0P0V0E0U0	ÓU0P0V0E0U0Á0E0U0P0E0V0E0W0E0U	ÓU0P0V0E0U0Á0E0U0U0E0S0E0 Ó0U0T0E0U0Á0E0W0E0S0Ó0E0U0P0 ÓU0P0V0E0U0	ÓU0P0V0E0U0Á0E0U0P0E0V0E0W0E0U	V0S0U0W0U0Á0E0Q0S0C Ú0E0U0E0U0U0	U0U0S0Ó0W
									
Ó0U0W0U0S0E0	U0U0S0Ó0W0Á0E0U0U0P0U0E0U0	Ó0U0U0U0Á0E0U0P0E0W0E0W0U0	ÚU0U0E0P0E0U0S0Á0E0Ó0E0S0D	ÚU0Ó0E0U0Á0E0V0U0U0W0U0Á0E0Q0 ÓS0Ó0U0Á0E0W0E0S0Q	QE0X0E0U0Á0E0U0E0V0E0U0	X0E0E0U0Á0E0Q0Ó0U0Q0E0 Q0X0U0U0D	QE0X0E0U0Á0E0V0S0E0U0E0Ó0U0S0U	V0E0E0U0T0E0U0	S0E0Q0E0U0Á0E0Q0U0X0E0P0U0W0P0 Q0U0D



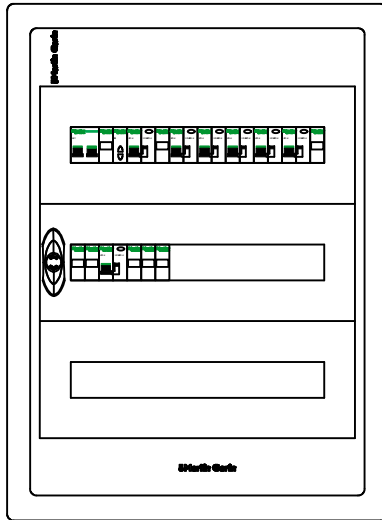





































ÓS0P0V0	Ó { ~ } ^ Á Á V [ð]	ÚU0Ó0W0U	GH I	Q0S0	F0E0I0^0d0Á0Á0E0]0E0E0^0d0Z0E0E0U0U0A0*
Q0U0E0VU	Ü ^ ð ð : æ ð } ^ Á Á ~ [ç æ Á d ^ c ^ ð Á [ð æ ^ Á ð ð { ~ } ð e	QE0P0Q0W	E	Q0E0V0E	G0E0F0E0G0H U0X0W0P0Ó U0E0E
		ÓW0Ó0P0E0U0	E	Ú0E0Q0E	F0æ Ú0Ó0W0
				V0E0U0S0E	

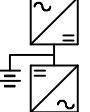

P~ [ç [ÁÛ~ aa! [Á|^cã [Áq] æcæ ^ } ç ÄZÜ ÒÈÖUÁK
 È Û~ aa! [ÁaaÁ &æ • [ÁUXÔÁ&] Á [!cæÁ æ] æ^ } ç
 È Ò^& : q } ^ÁU| €
 È Öq ÄÎ €ç | î çFGJ { {
 È ÇçFì DÁ | Á [á | ä
 È Q [{ Á €€
 È V^ } • q } ^ÁGEXÁ €P :
 È Q&Á È \ €

ÓSOPVO Ô [{ ~ } ^ÁÁV [ç [UUUÓOWU GH I	OSO FÉ [!^cã [Á^Áq] æcæ ^ } ç ÄZÜ ÒÈÖUÁK * E OÖVCE G-ÆFDEGH UOXWUPO U€E
UOEUWU Ü^aa : æ q } ^Áá~ [çaa c ç !cæ [&æ^ Á& [{ ~ } äe	ÖWÓOPœUÜO E	UÖÖCE T UÖÖW
		VOXUSCE

ŠÒÒÒPÖÖE
ÙQ ÓUŠQ

 QV00UWVU000WUT00U	 ÙQZWP00U00	 QV00UWVU000Q T00UXÙ000ZWP00U00	 ÙÙUV0ZWP0000T00E	 ÙÙUV0ZWP0000T00E	 ÙÙUV0ZWP0000T00E	 ÙÙUV0ZWP0000T00E	 ÙÙUV0ZWP0000T00E	 ÙÙUV0ZWP0000T00E	 ÙÙUV0ZWP0000T00E
 ÙÙUV0ZWP0000T00E	 ÙÙUV0ZWP0000T00E	 ÙÙUV0ZWP0000T00E	 ÙÙUV0ZWP0000T00E	 ÙÙUV0ZWP0000T00E	 ÙÙUV0ZWP0000T00E	 ÙÙUV0ZWP0000T00E	 ÙÙUV0ZWP0000T00E	 ÙÙUV0ZWP0000T00E	 ÙÙUV0ZWP0000T00E
 ÙÙUV0ZWP0000T00E	 ÙÙUV0ZWP0000T00E	 ÙÙUV0ZWP0000T00E	 ÙÙUV0ZWP0000T00E	 ÙÙUV0ZWP0000T00E	 ÙÙUV0ZWP0000T00E	 ÙÙUV0ZWP0000T00E	 ÙÙUV0ZWP0000T00E	 ÙÙUV0ZWP0000T00E	 ÙÙUV0ZWP0000T00E
 ÙÙUV0ZWP0000T00E	 ÙÙUV0ZWP0000T00E	 ÙÙUV0ZWP0000T00E	 ÙÙUV0ZWP0000T00E	 ÙÙUV0ZWP0000T00E	 ÙÙUV0ZWP0000T00E	 ÙÙUV0ZWP0000T00E	 ÙÙUV0ZWP0000T00E	 ÙÙUV0ZWP0000T00E	 ÙÙUV0ZWP0000T00E

ŠÒÒÒPÖÖE	ÙÙUV0ZWP0000T00E	GH I	QV00UWVU000WUT00U
ÙÙUV0ZWP0000T00E	ÙÙUV0ZWP0000T00E	E	ÙÙUV0ZWP0000T00E
ÙÙUV0ZWP0000T00E	ÙÙUV0ZWP0000T00E	E	ÙÙUV0ZWP0000T00E
ÙÙUV0ZWP0000T00E	ÙÙUV0ZWP0000T00E		ÙÙUV0ZWP0000T00E

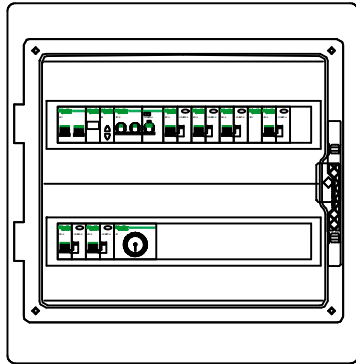

P [ç [ÁÛ ~ aa: [Á ^ c d [Á & ^ } d a ^ Á ^ { a a a } a c a ^ } ç ÁÛ Ò È Ò V È È U Á K
 È Û ~ aa: [Á Á a ^ c Á X Ó Á } Á [| c a a a } a ^ } c
 È Ò ^ & : a } ^ Á U Í Í
 È Ö a Ä Í € | | ì ç F Í € {
 È Ç ç F Ì D Á Í Á [a ' | a
 È Q [{ Á € O E
 È V ^ } • a } ^ Á G H E X Á € P :
 È Q & Á È \ O E

Ó S Ó P V Ó Ô [{ ~ } ^ Á Á V [a]

U U U O O W U G H I Ø S O F E [! * ^ ç [Á ^ Á } a a a ^ } ç U E ç Z U O E 0 V E E U 0 A *
 Ç È J Ó P Q W È Ø Ç V C E G H B E F D E G H U O X W U P Ó U E E

Ó W Ó Ó P Ç V U U Ó È U C E O C E T U C O W O

Q U O E V U Ü ^ a a : a a } ^ Á a ~ [ç a a d c | a a [& a ^ Á a } { ~ } a e



PUTÓÁÙÚÓÈÙÚ	
VOÞUΩΠPÓ	1 € QD
QÚÓÙÚÓÞZCE	1 € P:D
ÚΩVÈÖÖÖWÜU	VV
ÞUUT ÓÁÓÁΩΩUQ ÖÞVU	
QVÈÚÓÈÞVÓÈUQ ÓÓÁÞÞÁ€J1 Æ	
QVÈ ÚÓVÓÈUQ ÓÓÁÞÞÁ€J1 Æ	
ÓÈÈÚÓÈÞVÓÈUQ ÓÓÁÞÞÁ€J1 Æ	

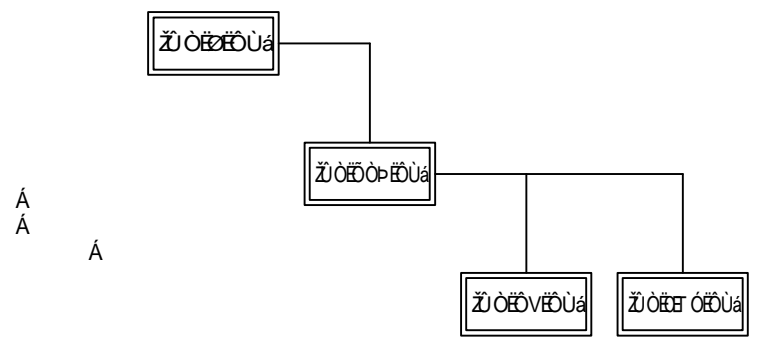

Á
Á

Á

P[{ ^Á^Á~ æi]	Ú~ æi [Ú~ æi]	Ú~ æi [Ú~ æi]	Ú~ æi [Ú~ æi]	Ú~ æi [Ú~ æi]					
Ó [! ^) c ^ Á [{ ã æ ^ Á C E D	Î H	F € €	I €	I €					
V ^) • ã } ^ Á [{ ã æ ^ Á X D	I € €	I € €	I € €	G H €					
Q & Æ Á * ! ^ • [Á C E D	J È	Î È	G È	F È Ì					
Ó æ ~ æ e) • ã } ^ Á ^ Á ~ æ i [Á A D	€	€ Æ	€ Æ	€ Æ					
Q [! { æ ã } ^ Á ^ Á ^ Á C E Þ È U O D	F € F € F € F € F €	F € H Æ € H Æ € H Æ €	F € I Æ € I Æ € I Æ €	F € I Æ € I Æ € I Æ €					
S ^) * @ : : æ ã ^ æ e D	F	H €	I Æ	I Æ					
P [! { æ ã ^ Á ^ Á ^ Á } d	Q ã ~ • d æ ^								Á

	ÓÓÞVÓ Ô [{ ~ } ^ Á Æ V [æ]	ÚÚÚÓÓWU ÖÈÚÓPQW ÖWÓÓÞÖVUÓ	E	QSCÈ [! * ^ c Æ Á ^ Á & ^) d [Á [& æ ^ Á , *	ÖÈVCE G # F B E G H ÚOXWUÞÓ U € € ÚCÈQCE F ÚCÓWÓ G
Q Ú Ö Þ V U Ú ^ Á Æ : æ ã } ^ Á ^ Á ~ [ç æ Æ c ^ c ^ æ [& æ ^ Á Æ [{ ~ } æ				VÖKUSCE	

ÔUT T QVÒP VÒK
 Ô[{ ~ } ^ ÁãÁ [æ]

ÔUT T ÒUÙØK
 GH Ì

Û^ æã : æ ã } ^ ÁãÁ ~ [çæÁ d ~ c | æÁ &æ^ ÁãÁ [{ ~ } ãe

ÛWOËÛK
 Û^ æã | ÁÒ^ c æ [ÁãÁ | } ã | æÁ^ } d [ÁÙ [&æ^

ÔCEÛOENVOÛQVÔPÒÁUWOËÛU

Q ÚOEVU ÁE U P V O
VÒPÙQ PÒÁ á €€ ØUÙEËP : á €
ÔUÙO P V O P U T E O O S A W O E U U A C E
Q&ÁUÙOËUWSÁWCEÛU A C E J E
ÛQVÔT QZQ P O M W U U V V
ÔQ ÔPÙQ P O E T ÔP V U Á U O C E U Ò Q Á C E Q & Á C E
ÔCEÛO P V O Û Q E T Ô V O C S S Ô C E
ÔSCEÛU O Ô C U S C E Ô P V U Q I I

P U Û T C E Q C E Q U O Û Q Ô P V U
Q V O Û U W V U Û Q Ô C E U S C E Q <input checked="" type="checkbox"/> — Ô C O P Á E I I E S
Q V O Û U W V U Û Q U O W S C E Q <input type="checkbox"/> — Ô C O P Á E I I E S
<input type="checkbox"/> — Ô C O P Á E I
Ô C E Û O P V O Û Q E <input checked="" type="checkbox"/> — Ô C O P Á F I H E S
<input type="checkbox"/> — Ô C O P Á I # Ô C O P Á E I E E
— Ô C O P Á J # Ô C O P Á E I E E
— Ô C O P Á F

ÔSOPVO Ô[{ ~ } ^ ÁãÁ [æ]	ÛUÙOËWU GH Ì	QSO C E [^ Á Á Á] d [Á & Á ^ Z U E E Z U O E Z O U A *
Q ÚOEVU Û^ æã : æ ã } ^ ÁãÁ ~ [çæÁ d ~ c æÁ &æ^ ÁãÁ [{ ~ } ãe	CEJOPQW E OCE	G B F D E G H UOXQWPÓ UERE
	ÔQOOPCEUÙO E UCEQCE F UCOVO	
	VOXUSCE	

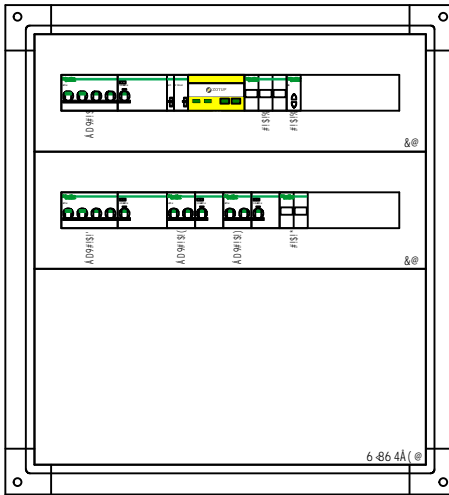

P~ [ç[ÁÛ~ æá[ÁÛ^cæ[Áæá[} æ | æÔ^} d[ÁÛ[&æ^ ÁÛ ÒÈÈÛÁK
 È æ{ æá[Áæ^c^ Á ^cæ[Á[} Á[|cæ[æ^} c^ Á
 •^|æ |æÁ&Öæ^
 È ^•^& : á } ^ÁÛ Í
 È åá È Á €í €€GJ€ {
 È æ • áæáGHEXæ
 È Q[{ Á HCE
 È V^} • á } ^Á €EXÁ EP:
 È Q&Á Í Á CE

	ÓS0PVO Ô[{ ~} ^ÁæV[æ[UUU00WU ÇJÓPQW ÓWÓÓPÇUÚÓ	GH I E E	0S0 ÇE[!^c Á^Á^} d[Á[&æ^ ÁÛ ÒÈÈÛÁK * G #FDEGH UOXWUPO UERE UCE@CE T U00W0
U0E0VU Ü^æá: æ á } ^Áæ~ [çæ^c^ c cæ[&æ^ Áæ[{ ~} æ				VOKUSCE

ÔUT T QVÒP VÒK
Ô[{ ~ } ^ ÁãÁ [æ]

ÔUT T ÒUÙOK
GH Ì

Ü^ æã : æ ã } ^ ÁãÁ ~ [çæÁ d~ c | æÁ [&æ^ ÁãÁ [{ ~ } ãe

ÛWÖÜUK

Û^ æã | ÁÒ^ c æ [ÁÔ^ } ^ | æ ^ ÁÔ^ } d [ÁÜ [&æ^

ÔCEÛOPVÒUQVQ PÒÁUWÖÜU

Q ÚOE VU ÁE U P VÒ ZUOEZUá
VÒPÙQ PÒÁ á €€ ØUÙE P : á €
ÔUÛUOPVÒPUT EÖÖSÁWÖÜU ÁEá
Q&ÁUÙUÛUWSÁWÖÜU ÁEá Ê
ÛQVÓT QZÖP ÖWÜU VV
ÖQ ÖPÙQ PÖE ÖP VU ÁUÖCEÛUÒ Q ÁEá Q&ÁEá
ÔCEÛUOPVÖUQE T ÖVÖSSÖQE
ÖSCEÛUÖÖQ U SÖE ÖP VU Q H

P U Û T ÖE V Q Ö Z Ö Q U Ö Q Ö P V U
Q V Ö Û U W V U Ü Q U Ö C E U S Ö E Q <input checked="" type="checkbox"/> — ÖÖÖPÁE I I E S
Q V Ö Û U W V U Ü Q U Ö W S Ö E Q <input type="checkbox"/> — ÖÖÖPÁE I I E S
<input type="checkbox"/> — ÖÖÖPÁE I
ÖCEÛUOPVÖUQE <input checked="" type="checkbox"/> — ÖÖÖPÁE I H I E S
<input type="checkbox"/> — ÖÖÖPÁE I # ÖÖÖPÁE I E E F
<input type="checkbox"/> — ÖÖÖPÁE J # ÖÖÖPÁE I E E S
<input type="checkbox"/> — ÖÖÖPÁE F



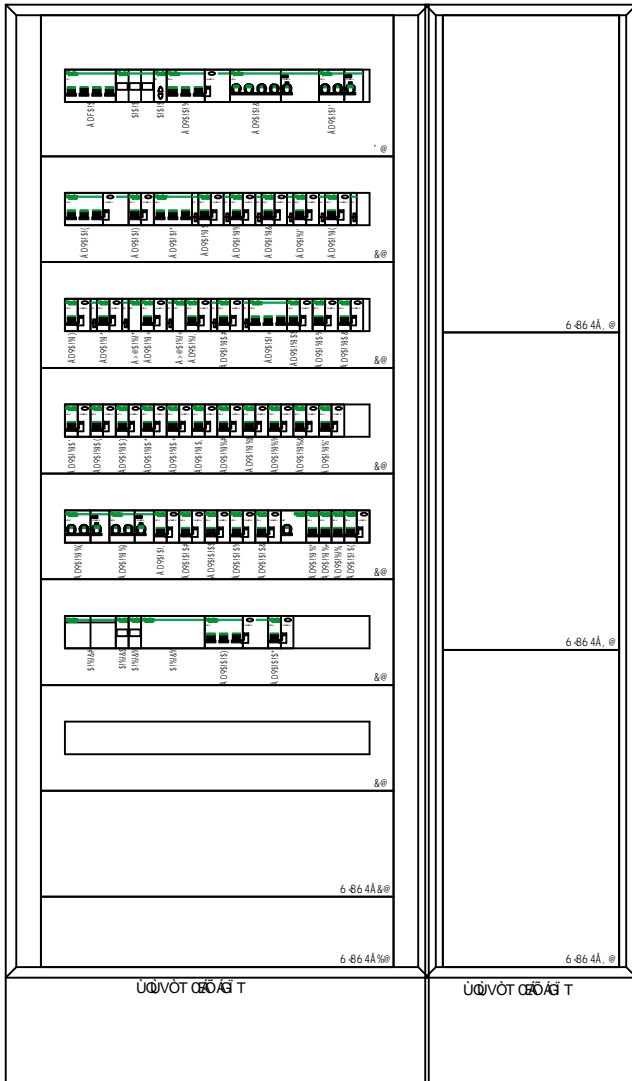
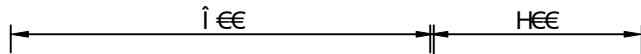































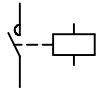

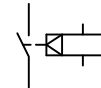

ÖSÖP VÖ	Ô[{ ~ } ^ ÁãÁ [æ]	ÛUÛÖÖWU	GH Ì	ÖSÖ	CE I I * d Á Á E N) d I Á I &æ^ ZU E F Á ZU Ö E Ö P E D U E Ü E *
Q ÚOE VU	Û^ æã : æ ã } ^ ÁãÁ ~ [çæÁ d~ c æÁ [&æ^ ÁãÁ [{ ~ } ãe	CEÛOPQW	E	ÖCEVCE	G B F E G H I UOXQW P Ö U E E E
		ÖQÖÖPCEUÜÖ	E	ÜCEÖQE	F UÖÖWÖ
				VÖKUSÖE	

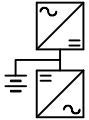

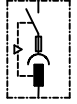
P` [ç [ÁÛ` æá [ÁÖ` c d æ [ÁÖ` } ^ i æ ÁÖ` } d [ÁÛ [& æ
 ΖΥΓΟΠΟΔΟΥ
 È æ { æ ã ä Á æ æ ã ^ } ç Á ^ æ æ Á æ } Á [i æ
 d æ] æ ^ } c Á Á ^ i i æ i æ Á & Ç æ ^
 È X æ [Á ã æ ã æ æ ã
 È ^ • ^ & : ã } ^ Á Û i H
 È á ã Æ í i € ç € ç G i {
 È æ • ã æ á G H E D I X æ
 È Q [{ Á € € €
 È V ^ } • ã } ^ Á € € X Á € P :
 È Q & Á € Á €

<p>ÓΣΩΠVÓ Ô { } ^ Á Á V [æ [</p>	<p>ΥΥΠΟΔΟΥ ÇÏÓΠQΩ ÓΩÓÓΠCΩ/ΥÓ</p>	<p>GH I E E</p>	<p>ΩΣΟ ÇE [^ c d Á Á } d [Á & æ ΖΥΓΑ ΖΥΓΟΠΟΔΟΥ * G B F D E G H UOXΩΠΠÓ U € € UCEQCE J UÓΩVÓ</p>
<p>Q U € V U Ü ^ æ ã : æ ã } ^ Á Á V` [ç Á c` c` i æ [& æ Á Á æ [{ } æ</p>			<p>VOKUSCE </p>

Š Ő Ő Ò Þ Ö Ę
 Û Ŧ Ó Ú Š Œ

									
Q V U U W V U U O A B W U T C E U	U O Z W Þ C E U U O	Q V U U W V U U O A B Q T C E U X U C E U O Z W Þ C E U U O	U U U V O Z W Þ O A O U T C E	U U U V O Z W Þ O A C E Þ O N W C E	U U U V O Z W Þ O A O W O U O Þ Z A E S O	U C E X C E F U V U U O	O S O T O Þ V U A W U C E S O	V U U U O	O U T C E O U A F C E W O S O
									
O U T C E O U A F U V U U Z C E U	U O C E O W A S O U U	T C E U X U C E U V C E O C E O S U O U U U V C E	Q V O U O S U O U	C E U C E O O C E P C E W U C E U C U X W O S O C E U U C E S O	O S U O O U A S O P C E O A O S O O C E U O U Þ A S U C E O O C E P C E A U U C Z W Þ O O A W U U U D	O S U O O U A S O P C E O A O S O O U Þ O U Þ C E U C E O O C E P C E A U U C Z W Þ O O C E U W U U U D	O U Þ V C E V U A B W A F C E W T O U U O Q O U Þ V C E V O U V C E S O B C E S V U C E V O O O W A O C E S U W O S O U C E V O O C E S S C E U C E O O C E P C E W U C E C E W O O A W S O U Þ V C E V U D	O U O C E A F C E T C E N O Þ U W Þ O	O U O C E A S O C E O W A O S O U U O Þ O
									
O U T T W C E U U O A O U A N W U T O Þ V Q Q U S T O N U O W B E F U O U T O N U O W U D	C E U O U T O N U U	X U S T O N U U	A O O W O Þ Z A O N U U	U N U W T O Þ V U A O V O O U C E U U O Q U Þ V C E V U U O D	O U Þ V C E V U U O O U Þ O U Þ V C E V O U	O U Þ V C E V U U O O U Þ A U U U O C E O C E O A O U T C E O U A F C E W O S O O U Þ O U Þ V C E V O U	O U Þ V C E V U U O O U Þ O U Þ V C E V O U	V O S O U W V U U O O Q O S O C U C E U U W C E U U U D	U U U S U O W
									
O U O U W O U S C E O	U U U S U O W A S E V U U P U T O U	O U U U U O A O U Þ V C E W O S O U U O D	U U O U C E P C E O U S U A O C E O S O S O D	U U O O C E U Þ A O V O O U W V U U O O Q O S U O O U O A O S O W O S O	C E X C E U U O O U O U A N V C E V O U	X C E C E U U O O Q O S U O O W C E Q X O U V O U D	C E X C E U U O O A V O S S C E U O O U S U	V U C E O U T C E U U O	S O T C E U U O O Q O U U X U C E O Þ U W Þ O Q U O O D

Ó S O Þ V O	Ô { ~ } ^ Á Æ Å [æ]	U U U O O W U	G H I	O S O	C E { ~ } ^ Á Æ Å [æ]	U O X W O Þ O	U C E
Q U O E V U	Û ^ æ ã : æ ã } ^ Á Æ Å [ç æ Å c ~ æ Å [æ Æ Á Æ Å [{ ~ } æ	C E J O P Q X W		E	O C E V C E	G B F D E G H	
		O W O O Þ C E U U O		E	U C E O C E	F æ	U O O W O
					V O K U S C E		

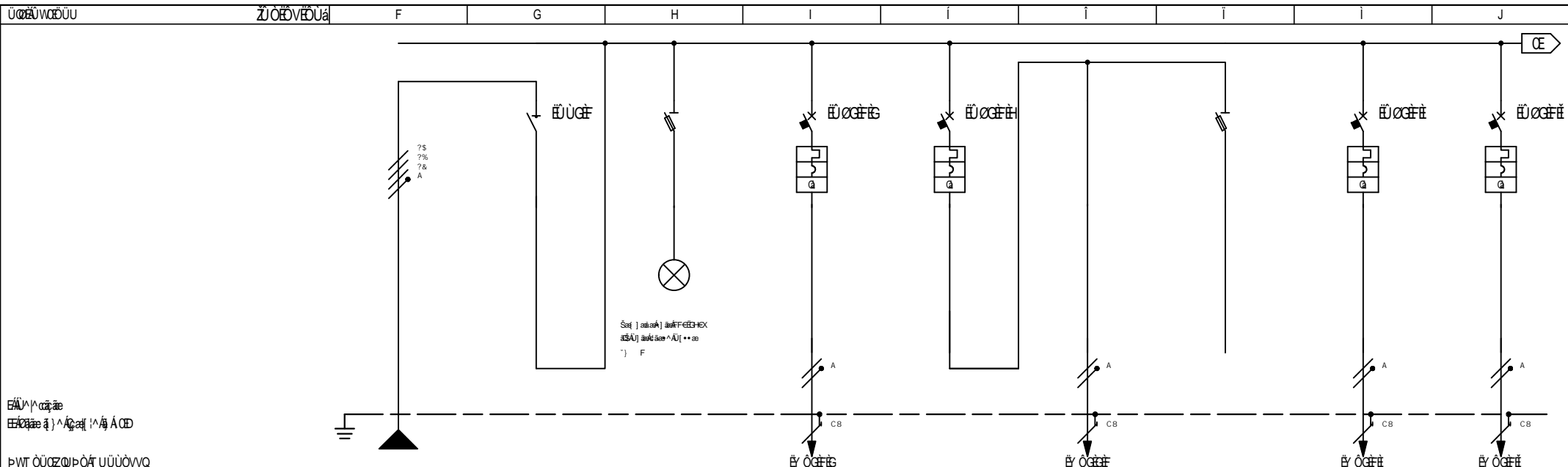

ΠΥΛΩΝΟΜΕΝΟ			ΖΗΤΩΝΕΥΟΜΕΝΟ			F			G			H			I			J		
ΠΥΛΩΝΟΜΕΝΟ	ΖΗΤΩΝΕΥΟΜΕΝΟ	ΣΥΣΤΗΜΟ	ΠΥΛΩΝΟΜΕΝΟ	ΖΗΤΩΝΕΥΟΜΕΝΟ	ΣΥΣΤΗΜΟ	ΠΥΛΩΝΟΜΕΝΟ	ΖΗΤΩΝΕΥΟΜΕΝΟ	ΣΥΣΤΗΜΟ	ΠΥΛΩΝΟΜΕΝΟ	ΖΗΤΩΝΕΥΟΜΕΝΟ	ΣΥΣΤΗΜΟ	ΠΥΛΩΝΟΜΕΝΟ	ΖΗΤΩΝΕΥΟΜΕΝΟ	ΣΥΣΤΗΜΟ	ΠΥΛΩΝΟΜΕΝΟ	ΖΗΤΩΝΕΥΟΜΕΝΟ	ΣΥΣΤΗΜΟ			
ΠΥΛΩΝΟΜΕΝΟ						ΖΗΤΩΝΕΥΟΜΕΝΟ						ΣΥΣΤΗΜΟ								
ΟΔΟΤΡΟΦΕΣ						ΟΔΟΤΡΟΦΕΣ						ΟΔΟΤΡΟΦΕΣ								
ΠΥΛΩΝΟΜΕΝΟ						ΖΗΤΩΝΕΥΟΜΕΝΟ						ΣΥΣΤΗΜΟ								
ΟΔΟΤΡΟΦΕΣ						ΟΔΟΤΡΟΦΕΣ						ΟΔΟΤΡΟΦΕΣ								
ΟΔΟΤΡΟΦΕΣ						ΟΔΟΤΡΟΦΕΣ						ΟΔΟΤΡΟΦΕΣ								
ΟΔΟΤΡΟΦΕΣ						ΟΔΟΤΡΟΦΕΣ						ΟΔΟΤΡΟΦΕΣ								
ΟΔΟΤΡΟΦΕΣ						ΟΔΟΤΡΟΦΕΣ						ΟΔΟΤΡΟΦΕΣ								
ΟΔΟΤΡΟΦΕΣ						ΟΔΟΤΡΟΦΕΣ						ΟΔΟΤΡΟΦΕΣ								
ΟΔΟΤΡΟΦΕΣ						ΟΔΟΤΡΟΦΕΣ						ΟΔΟΤΡΟΦΕΣ								
ΟΔΟΤΡΟΦΕΣ						ΟΔΟΤΡΟΦΕΣ						ΟΔΟΤΡΟΦΕΣ								
ΟΔΟΤΡΟΦΕΣ						ΟΔΟΤΡΟΦΕΣ						ΟΔΟΤΡΟΦΕΣ								
ΟΔΟΤΡΟΦΕΣ						ΟΔΟΤΡΟΦΕΣ						ΟΔΟΤΡΟΦΕΣ								
ΟΔΟΤΡΟΦΕΣ						ΟΔΟΤΡΟΦΕΣ						ΟΔΟΤΡΟΦΕΣ								
ΟΔΟΤΡΟΦΕΣ						ΟΔΟΤΡΟΦΕΣ						ΟΔΟΤΡΟΦΕΣ								
ΟΔΟΤΡΟΦΕΣ						ΟΔΟΤΡΟΦΕΣ						ΟΔΟΤΡΟΦΕΣ								
ΟΔΟΤΡΟΦΕΣ						ΟΔΟΤΡΟΦΕΣ						ΟΔΟΤΡΟΦΕΣ								
ΟΔΟΤΡΟΦΕΣ						ΟΔΟΤΡΟΦΕΣ						ΟΔΟΤΡΟΦΕΣ								
ΟΔΟΤΡΟΦΕΣ						ΟΔΟΤΡΟΦΕΣ						ΟΔΟΤΡΟΦΕΣ								
ΟΔΟΤΡΟΦΕΣ						ΟΔΟΤΡΟΦΕΣ						ΟΔΟΤΡΟΦΕΣ								

ΠΥΛΩΝΟΜΕΝΟ						ΖΗΤΩΝΕΥΟΜΕΝΟ						ΣΥΣΤΗΜΟ					
ΟΔΟΤΡΟΦΕΣ						ΟΔΟΤΡΟΦΕΣ						ΟΔΟΤΡΟΦΕΣ					
ΟΔΟΤΡΟΦΕΣ						ΟΔΟΤΡΟΦΕΣ						ΟΔΟΤΡΟΦΕΣ					
ΟΔΟΤΡΟΦΕΣ						ΟΔΟΤΡΟΦΕΣ						ΟΔΟΤΡΟΦΕΣ					
ΟΔΟΤΡΟΦΕΣ						ΟΔΟΤΡΟΦΕΣ						ΟΔΟΤΡΟΦΕΣ					
ΟΔΟΤΡΟΦΕΣ						ΟΔΟΤΡΟΦΕΣ						ΟΔΟΤΡΟΦΕΣ					

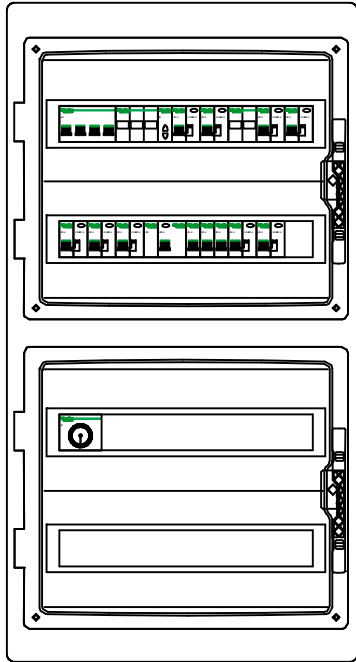

P [ç [ÁÛ ãi [Á ^ c d [Á ^ } d a ^ Á { ã a ^ } d [Á [& a ^ ÁÛ ÒÈÖVÈÙaK
 È Û ãi [Á a ^ c Á X Ô Á } Á [| c a ^ a } a ^ c
 È Ò ^ & : a } ^ Á Û Í Í
 È Ö a È Ì G | | ì ç F Í € {
 È Ç ç F Ì D Ì G Á [a | ã
 È Q [{ Á € E
 È V ^ } • a } ^ Á G H X Á € P :
 È Q & Á È \ Ç E

	ÓS0PVO Ô { ~ } ^ Á a V [a [UUU00WU ÇEJOPQW ÖW00P0E/UU0	GH I ÖS0 ÇE ^ c Á ^ Á ^ } d [Á [& a ^ ZUeG ZUOE0VE0Ua * E ÖC/E G # F B E G H UOXW/P0 UeE E UOE0CE T U00W0
U0E0VU Ü a ã : a a } ^ Á a ~ [ç a d c c a [& a ^ Á a { ~ } a e			VOKUSCE 

ÔUT T QVÒP VÒK
 Ô[{ ~ } ^ ÁãÁ [æ]

ÔUT T ÒUÙØK
 GH Ì

Ü^ æã : æ ã } ^ ÁãÁ ~ [çæÁ d~ cç | æÁ [&æ^ ÁãÁ [{ ~ } ãe

ÛWÖÜÜK

Û^ æã | ÁÒ^ çã [ÁØ æ à ~ | æ [ã ÁÔ^ } d [ÁÛ [&æ^

ÔEÛCEVÒÜØVØPÒÁWÖÜU

Q ÚØE VU ÁØE U P V Ø ZÜ Ö E Ö P E Ü Á
VØP U Ø P Ø Á á € € Ø U Ø E P : á €
Ø U Ø Ø P V Ø P U T E Ø O S Á W Ö Ü U Á Ø E
Q & Á U Ø Ø E U W S Á W Ö Ü U Á Ø E
U Ø V Ø T Ø Ø Ø P Ø W Ü U
Ø Q Ø P U Ø P Ø E Ø P V U Á Ø C E Ü Ø Q Á Ø E Q & Á Ø E
Ø C E Ü Ø P V Ø Ø E
Ø S C E Ü Ø Ø C Ø U S C E Ø P V U

P U Ü T C E V Q Ø Ø C Á Ø Ø Ø P V U
Ø V Ø Ü W V U Ü Ø Ø C E U S C E Q <input checked="" type="checkbox"/> — Ø Ø Ø P Á E I I E S
Ø V Ø Ü W V U Ü Ø U Ø W S C E Q <input type="checkbox"/> — Ø Ø Ø P Á E I I E S
<input type="checkbox"/> — Ø Ø Ø P Á E I
Ø C E Ü Ø P V Ø Ø E <input checked="" type="checkbox"/> — Ø Ø Ø P Á F I H E S
<input type="checkbox"/> — Ø Ø Ø H I # Ø Ø Ø P Á E I E E
<input type="checkbox"/> — Ø Ø Ø H J # Ø Ø Ø P Á E I E E
<input type="checkbox"/> — Ø Ø Ø H F

Ø Ø Ø P V Ø	Ô [{ ~ } ^ ÁãÁ [æ]	Ü Ü U Ø Ø W U	GH Ì	Ø Ø Ø	Ø E ^ ç æ Á d ç æ Á d ~ c ç æ Á [& æ ^ Á ç Á [{ ~ } ã e	ZÜ Ö E F Ö E Ü Á *
Ø E Ø P Q W		Ø Ø Ø P C E U Ø Ø		E Ø C E	G Ø F Ø E Ø H	U Ø X Ø W Ø P Ø U E E
Ø Ø Ø Ø P C E U Ø Ø				E U Ø Ø C E	F	U Ø Ø W Ø
Q ÚØE VU	Û^ æã : æ ã } ^ ÁãÁ ~ [çæÁ d~ cç æÁ [&æ^ ÁãÁ [{ ~ } ãe			V Ø K U S C E		

COMMITTENTE:
Comune di Toano

COMMESSA:
2387
Realizzazione di nuova struttura sociale di comunità

QUADRO:
CABLAGGIO STRUTTURATO

	CLIENTE	Comune di Toano	PROGETTO	2387	FILE	3-Cablaggio Strutturato Centro Sociale		
			ARCHIVIO	-	DATA	24/11/2023	REVISIONE	R0.0
			DISEGNATORE	-	PAGINA	1	SEGUE	
	IMPIANTO	Realizzazione di nuova struttura sociale di comunità	TAVOLA					

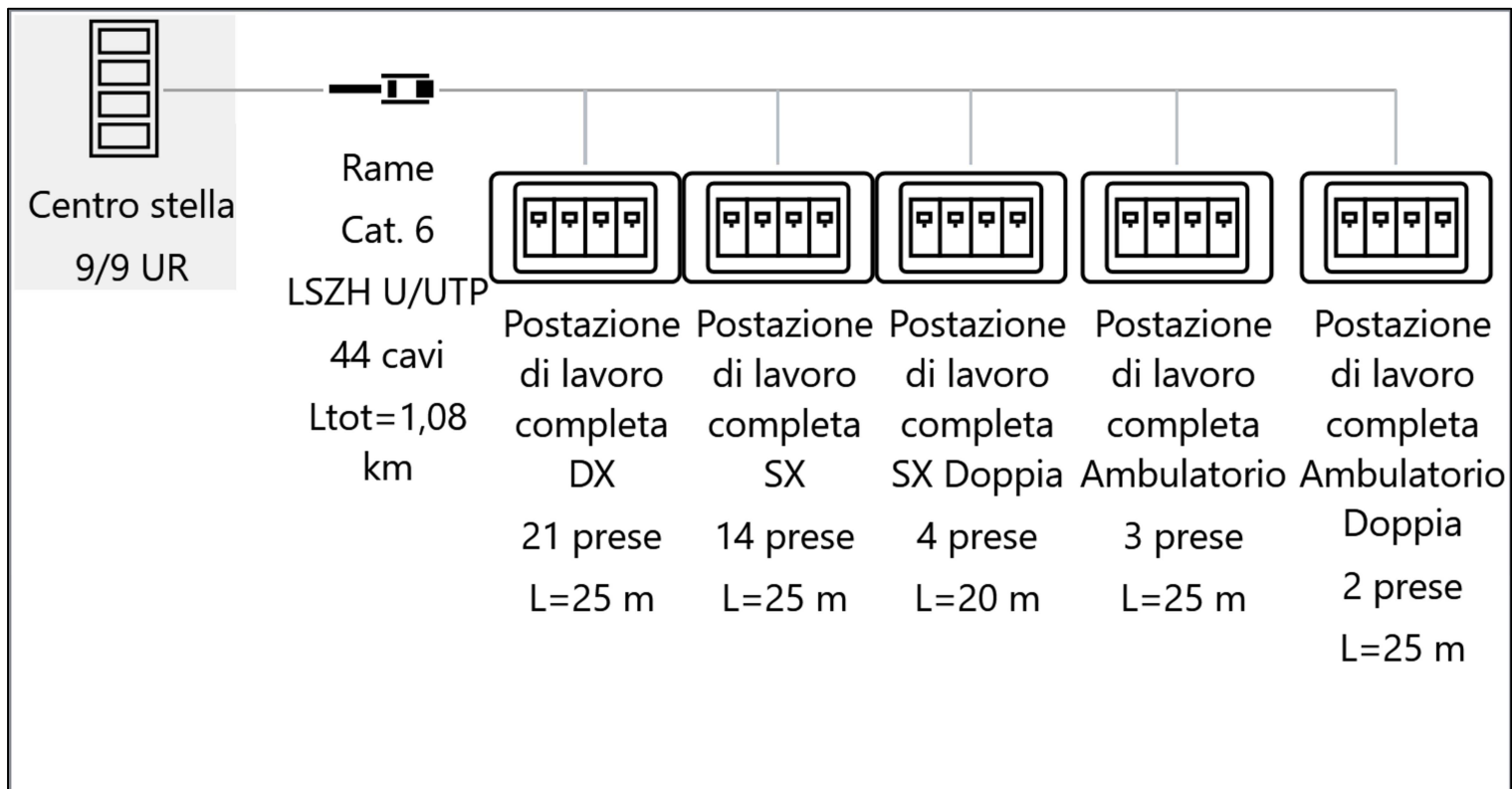

CLIENTE Comune di Toano

PROGETTO 2387

FILE 3-Cablaggio Strutturato Centro Sociale

ARCHIVIO - DATA 24/11/2023 REVISIONE R0.0

DISEGNATORE - PAGINA 2 SEGUE

IMPIANTO Realizzazione di nuova struttura sociale di comunità

TAVOLA

600mm x 21U

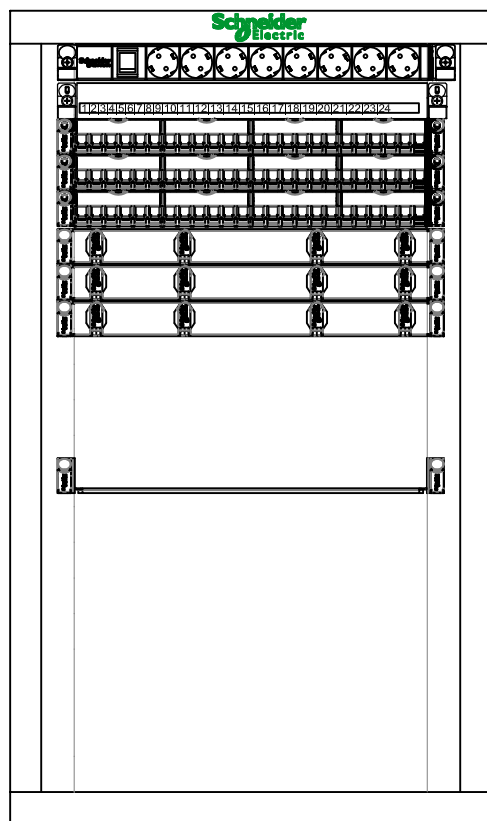

Nuovo Rack Dati Centro Sociale [Centro stella] :

- Cassetta OPB 21U fianchi apribili 1050x600x600 (1)
- Pan.ottico Actassi V2 (1)
- Piastra 3 SC duplex per Actassi (1)
- Bussola SC Duplex MM (3)
- Pigtail OM3 50/125 SC 1m (6)
- Kit Vass portag (Max. 24 fibre) (1)
- Data Actassi 24 equip. cat6 UTP S-One (1)
- Data Actassi 24 equip. cat6 UTP S-One (1)
- Data Actassi 24 equip. cat6 UTP S-One (1)
- Alim. Actassi 8 schuko+int.lum. (1)
- Passacavi orizzontale Actassi (1)
- Passacavi orizzontale Actassi (1)
- Passacavi orizzontale Actassi (1)
- Ripiano metallico Actassi 19" (1)

CLIENTE	Comune di Toano	
	PROGETTO	2387
	ARCHIVIO	-
IMPIANTO	Realizzazione di nuova struttura sociale di comunità	
	DISEGNAZIONE	-
	TAVOLA	

FILE	3-Cablaggio Strutturato Centro Sociale	
DATA	24/11/2023	REVISIONE
PAGINA	3	SEGUE